



ÉCOLE POLYTECHNIQUE
FÉDÉRALE DE LAUSANNE

Microgrid EPFL – Méthodes innovantes issues de la recherche

Prof. Mario Paolone
Distributed Electrical Systems Laboratory

**Smart Grids –
Solutions intelligentes pour les sites et les villes**
Mardi 5 décembre 2017, Berne

Classical ctrl approaches in energy systems

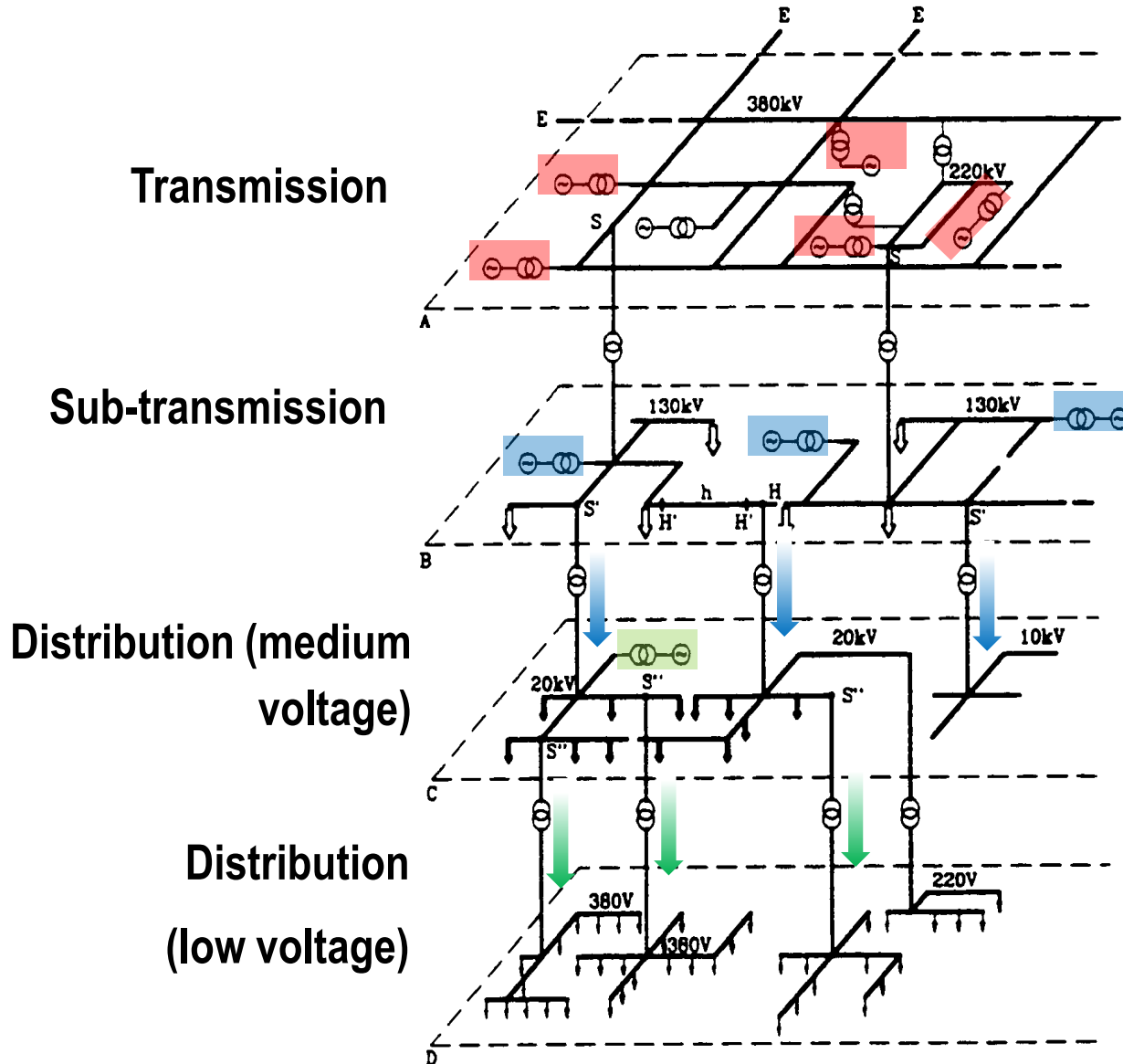

In traditional power systems, the **sources of uncertainties** are represented by the **loads**.



Majority of the control problems are solved in the **planning (years)** or **dispatching (day)** stages.

Importance of uncertainties of renewables

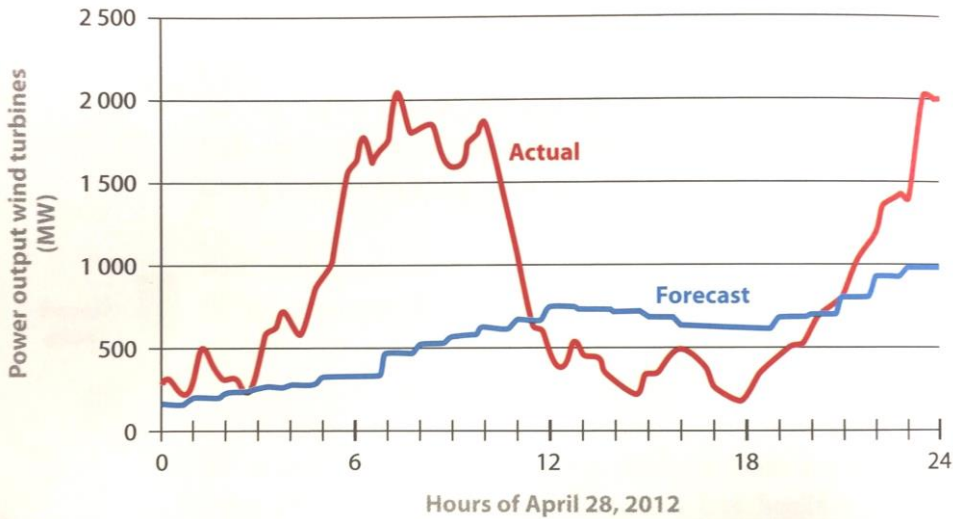

Example of deviation from predicted and actual power output from wind turbines in the German Amprion TSO region, April 28, 2012.

Example of deviation from predicted and actual power power injected by solar arrays at EPFL

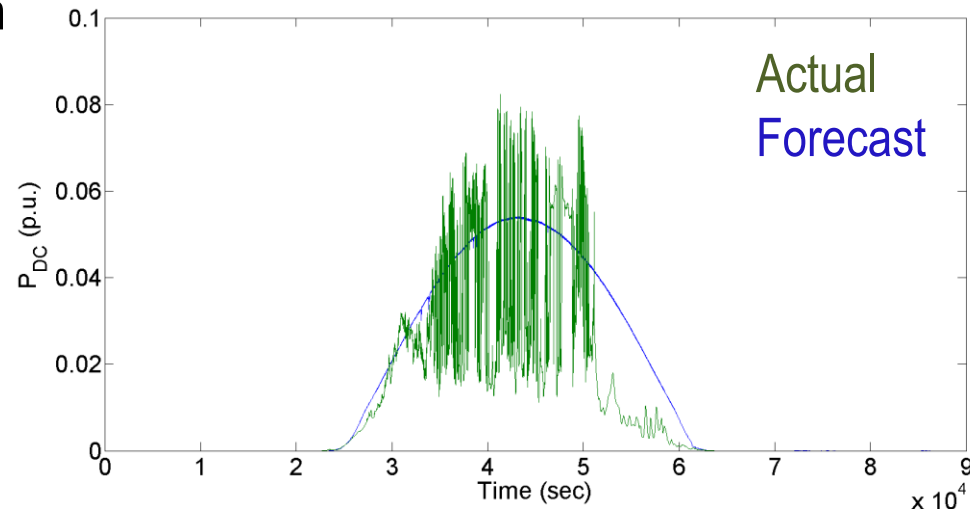

Classical ctrl approaches in energy systems

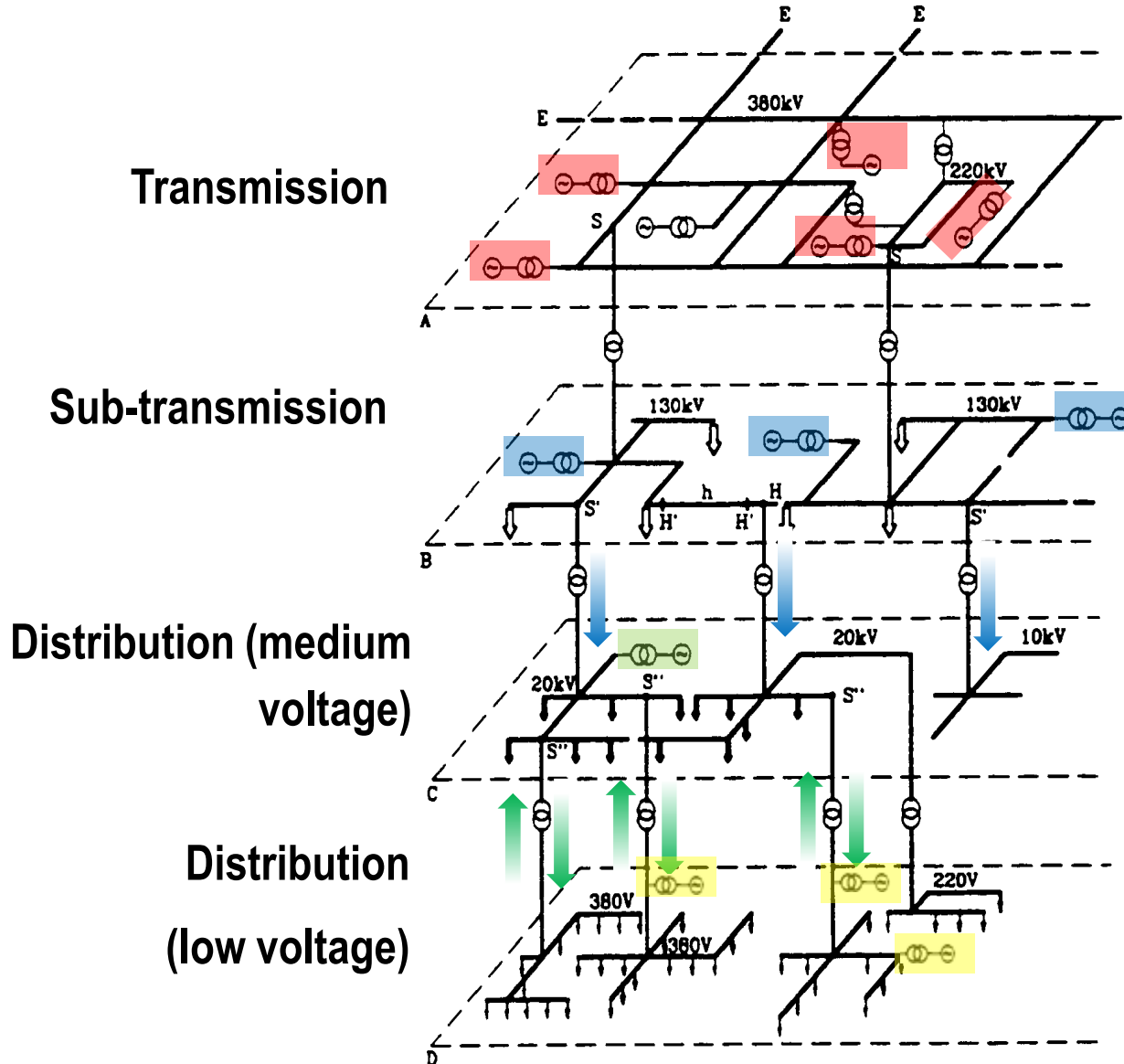

Massive deployment of distributed energy resources → **large uncertainties come from injections**



Control problems are solved in the planning (years), dispatching (day) and **real-time**.

Methodological/technological challenges in smart grids

	Problem	Required methods	Required technologies
ms	<ul style="list-style-type: none"> Renewables short-term volatility 	<ul style="list-style-type: none"> Real-time knowledge of the system state 	<ul style="list-style-type: none"> Distributed sensing (e.g. PMU) Real-time state estimators
secs-mins	<ul style="list-style-type: none"> Grid congestions Voltage control 	<ul style="list-style-type: none"> Exact optimal power flow Explicit control methods Stability assessment of complex systems (low inertia) 	<ul style="list-style-type: none"> Distributed storage
months	<ul style="list-style-type: none"> Heterogeneous resources aggregation Ancillary services (system stability) 	<ul style="list-style-type: none"> Real-time estimation of system flexibility Robust optimization Short-term forecast 	<ul style="list-style-type: none"> Agent-based software frameworks Demand response New technologies in pumped hydro

Sensing: situation awareness and functions

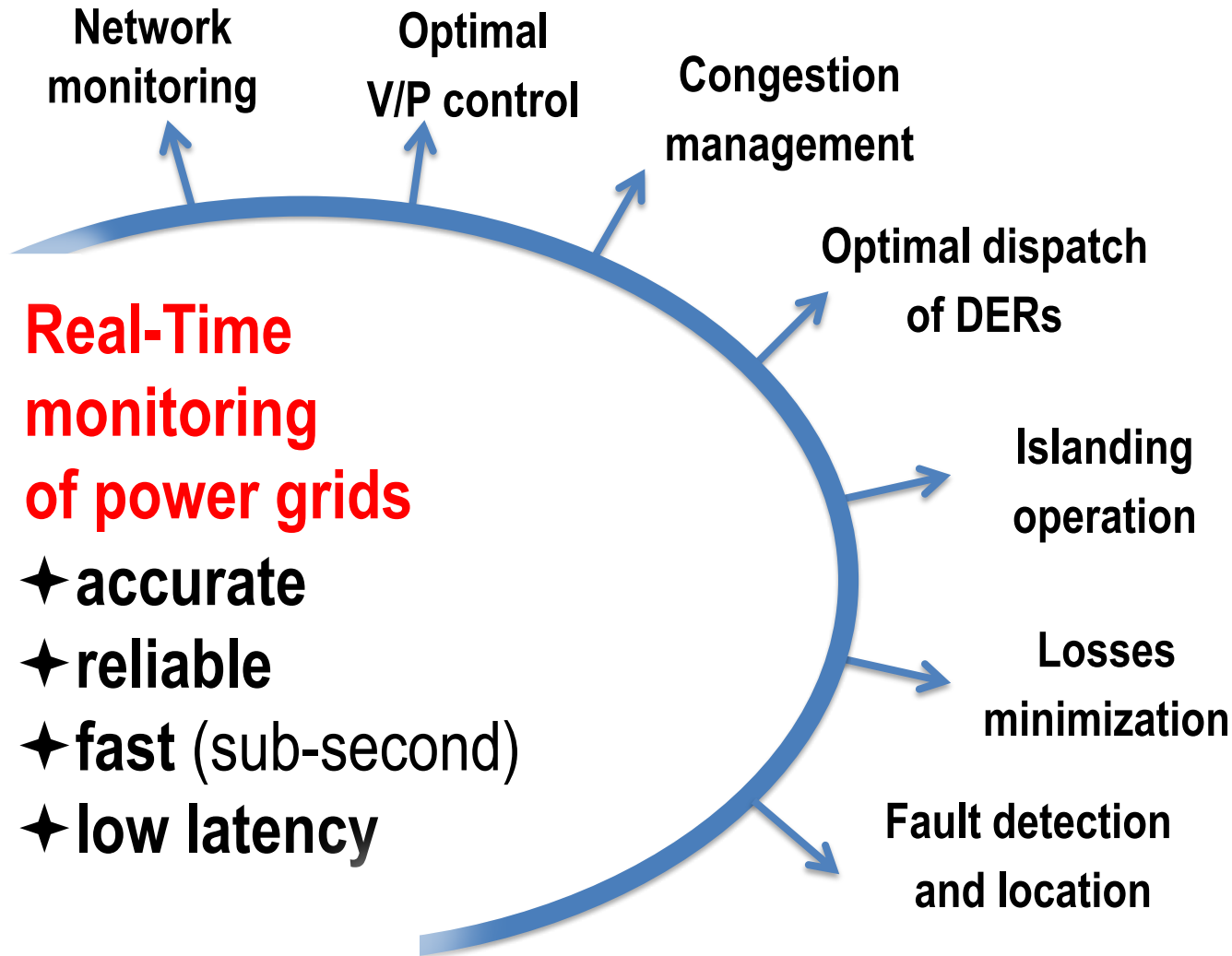

Sensing: technologies and time synchronisation

Drivers Availability of new technologies (e.g., precise time dissemination)
→ Enable new situation-awareness and control schemes in power grids

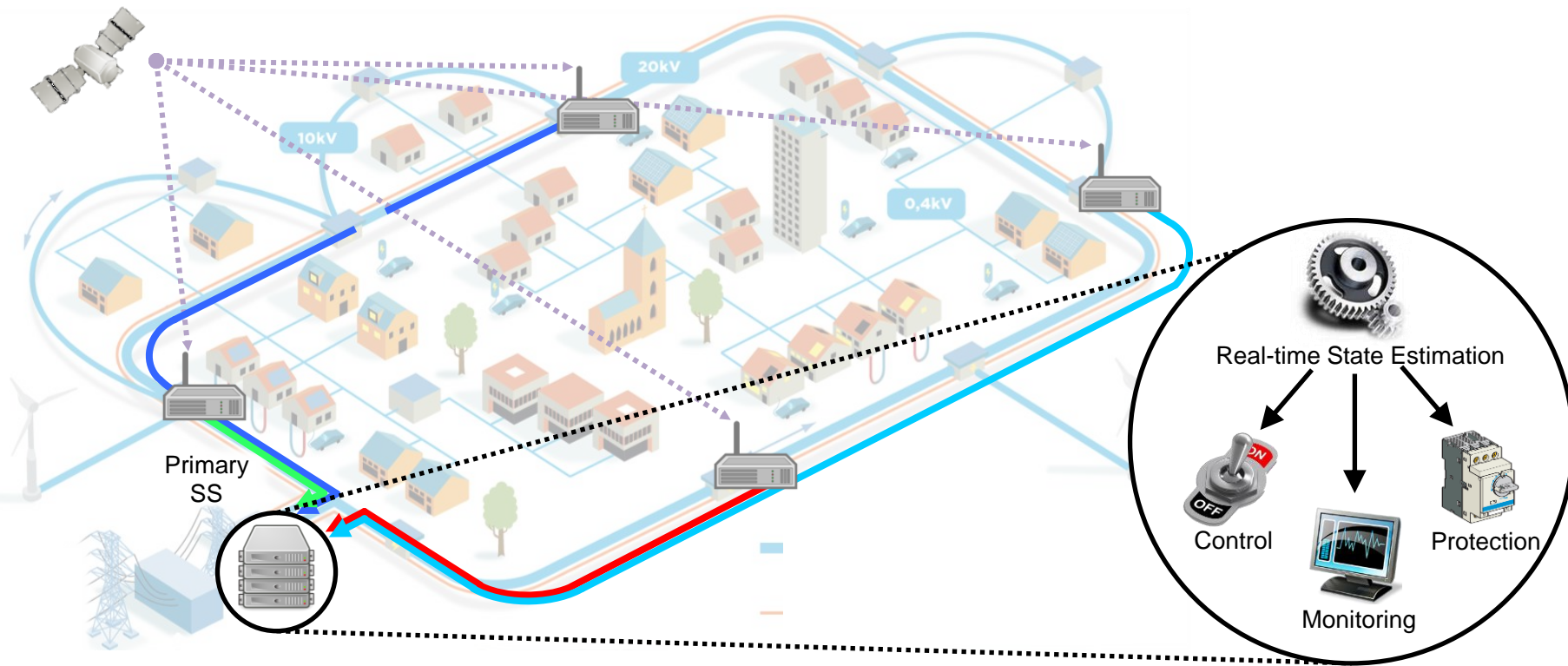

Sensing: real-time state estimation via PMUs

Definition

Phasor Measurement Unit

(IEEE Std.C37.118-2011)

“A device that produces **synchronized measurements of phasor** (i.e. its **amplitude and phase**), **frequency**, **ROCOF** (**Rate of Change Of Frequency**) from voltage and/or current signals based on a **common time source** that typically is the one provided by the **Global Positioning System UTC-GPS.**”

Sensing: the EPFL PMU metrological performances

SINGLE TONE SIGNALS

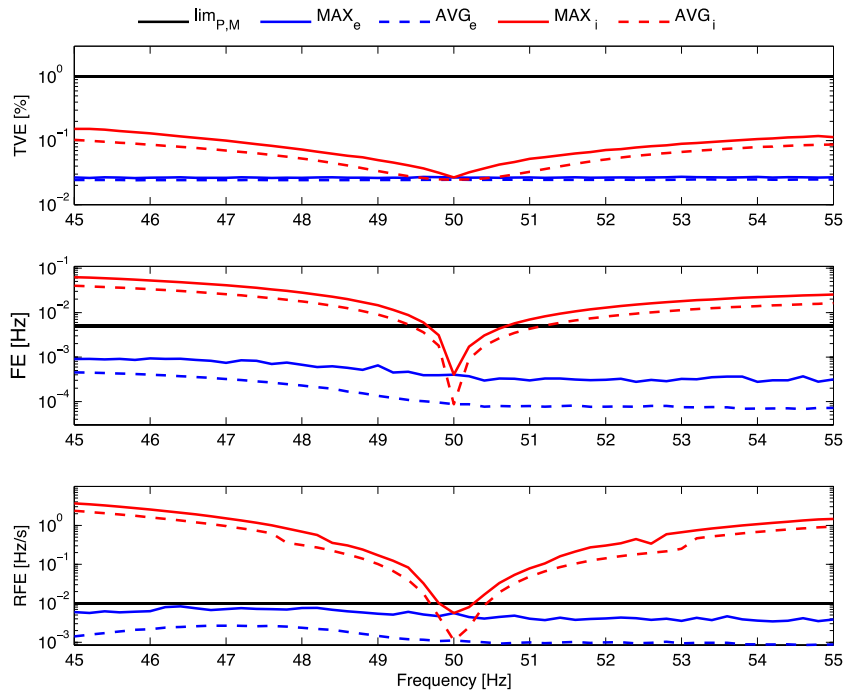

Comments:

- $\text{TVE}_{\max} = 0.027\%$ – $\text{TVE}_{\text{avg}} = 0.024\%$ ($1.5 \mu\text{rad}$)
- $\text{FE}_{\max} = 4 \cdot 10^{-4}$ – $\text{FE}_{\text{avg}} = 9 \cdot 10^{-5}$
- $\text{RFE}_{\max} = 6 \cdot 10^{-3}$ – $\text{RFE}_{\text{avg}} = 1 \cdot 10^{-3}$

MULTI TONE SIGNALS

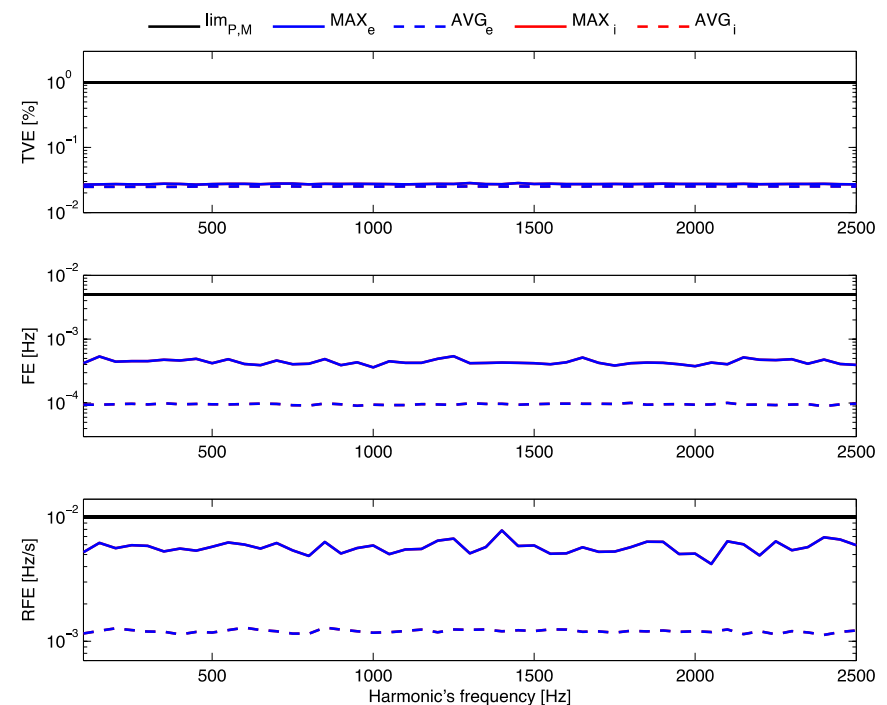

Comments:

- Identical performances w.r.t. single tone signals
- Perfect harmonic rejection

Methodological/technological challenges in smart grids

	Problem	Required methods	Required technologies
ms	<ul style="list-style-type: none"> Renewables short-term volatility 	<ul style="list-style-type: none"> Real-time knowledge of the system state 	<ul style="list-style-type: none"> Distributed sensing (e.g. PMU) Real-time state estimators
secs-mins	<ul style="list-style-type: none"> Grid congestions Voltage control 	<ul style="list-style-type: none"> Exact optimal power flow Explicit control methods Stability assessment of complex systems (low inertia) 	<ul style="list-style-type: none"> Distributed storage
months	<ul style="list-style-type: none"> Heterogeneous resources aggregation Ancillary services (system stability) 	<ul style="list-style-type: none"> Real-time estimation of system flexibility Robust optimization Short-term forecast 	<ul style="list-style-type: none"> Agent-based software frameworks Demand response New technologies in pumped hydro

Real-Time State Estimation via PMUs

Availability of new technologies

→ Enable new protection and control schemes

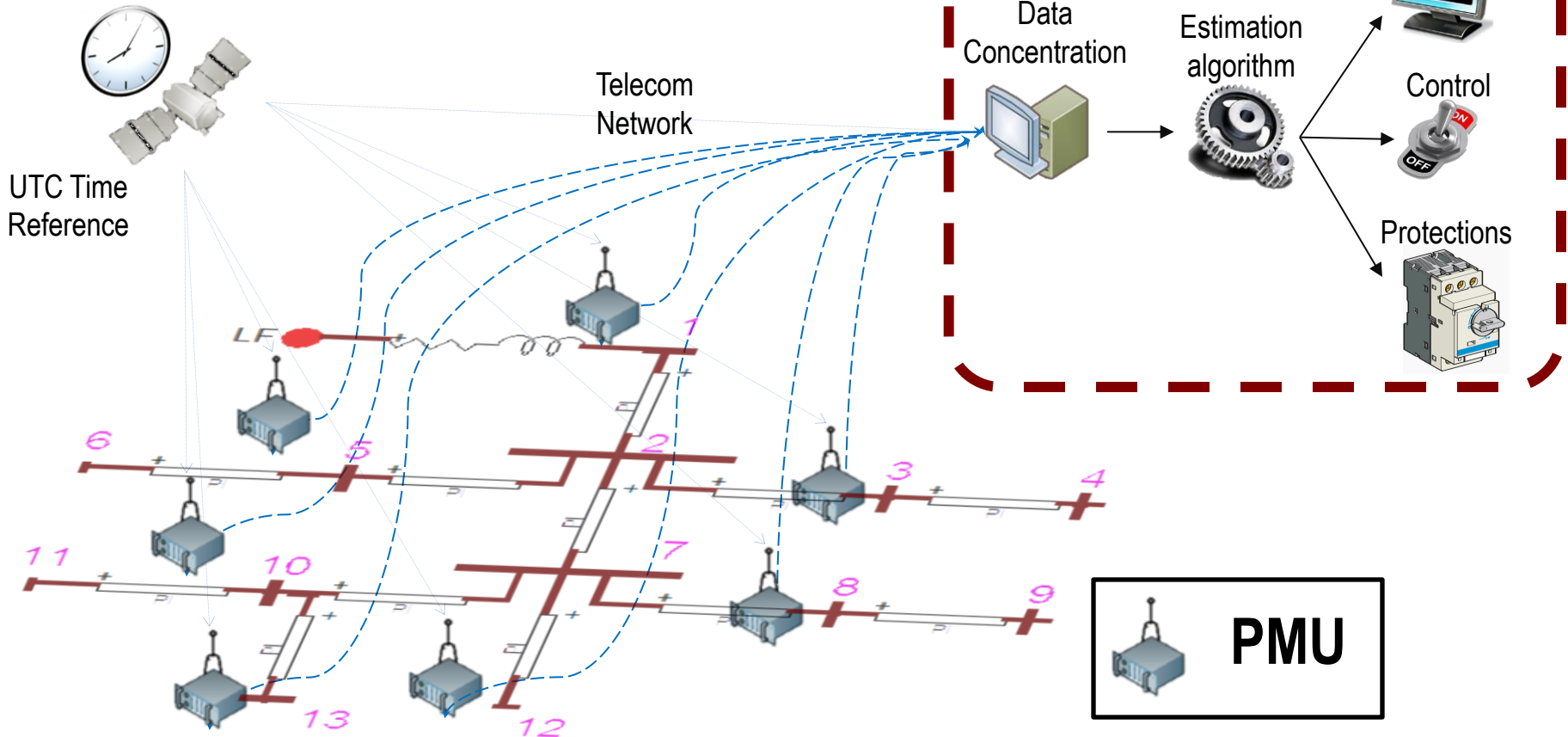

Real-Time State Estimation via PMUs

Definition 1/2

To fix the ideas, in what follows with the term

Real-Time State Estimation – RTSE

we make reference to the process of **estimating the network state** (i.e., **phase-to-ground node voltages**) with an **extremely high refreshing rate** (typically of **several tens of frames per second**) enabled by the use of **synchrophasor measurements**.

Real-Time State Estimation via PMUs

Use cases

Monitoring

- Real-time visualization and alarming
- Real-time State Estimation
- Post-event analysis
- Planning of grid reinforcement due to excessive DER penetration
- Asset management
- Equipment misoperation
- System health monitoring
- ...

Protection

- Fault identification
- Fault location
- Fault isolation

Control

- Voltage control
- Line congestion management
- Distributed resources control (e.g., electrochemical storage)
- Network islanding (and reconnection)
- System restoration

Methodological/technological challenges in smart grids

ms
secs-mins
time
months

Problem	Required methods	Required technologies
<ul style="list-style-type: none"> Renewables short-term volatility 	<ul style="list-style-type: none"> Real-time knowledge of the system state 	<ul style="list-style-type: none"> Distributed sensing (e.g. PMU) Real-time state estimators
<ul style="list-style-type: none"> Grid congestions Voltage control 	<ul style="list-style-type: none"> Exact optimal power flow Explicit control methods Stability assessment of complex systems (low inertia) 	<ul style="list-style-type: none"> Distributed storage
<ul style="list-style-type: none"> Heterogeneous resources aggregation Ancillary services (system stability) 	<ul style="list-style-type: none"> Real-time estimation of system flexibility Robust optimization Short-term forecast 	<ul style="list-style-type: none"> Agent-based software frameworks Demand response New technologies in pumped hydro

Optimal real-time explicit control

The COMMELEC control framework – Main features

- inexpensive platforms (embedded controllers)
- scalability
- do not build a monster of complexity - bug-free

Such a control framework must be

- scalable
- composable

(i.e. built with identical small elements)

COMMELEC's Architecture

- **Software Agents** associated with devices
 - load, generators, storage
 - grids
- **Grid agent sends explicit *power setpoints*** to devices' agents

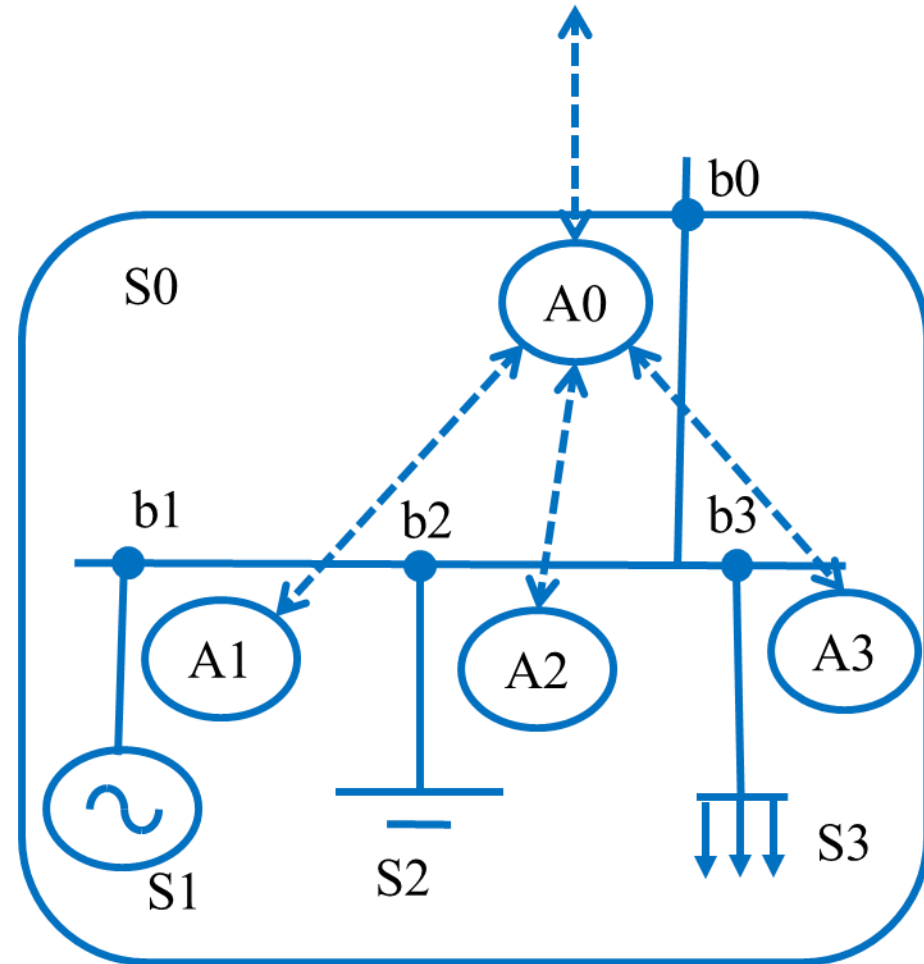

COMMELEC's Architecture

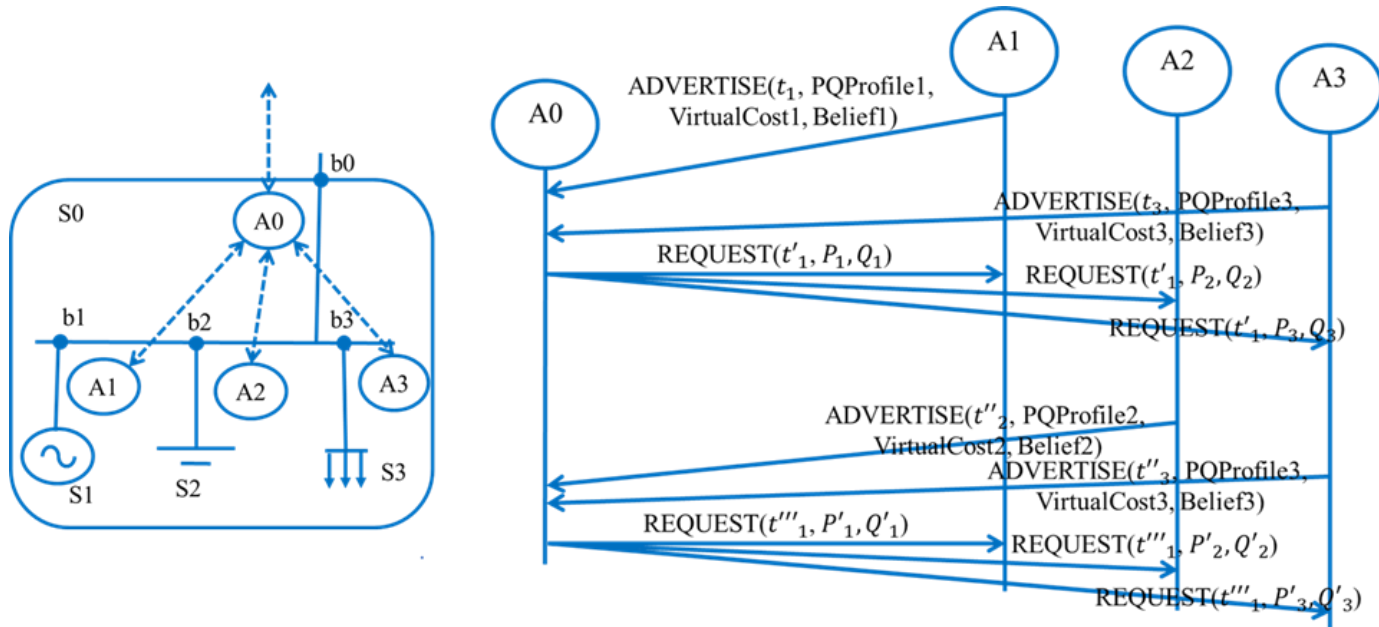

- Every agent **advertises** its state (example each 100 ms) as a ***PQt profile***, a ***virtual cost*** and a ***belief function***
- Each Grid agent computes optimal setpoints and sends them as **requests** to resource agents.

COMMELEC's Architecture – The PQt Profile

PQt profile: constraints on active/reactive power setpoints

Examples of PQt profiles

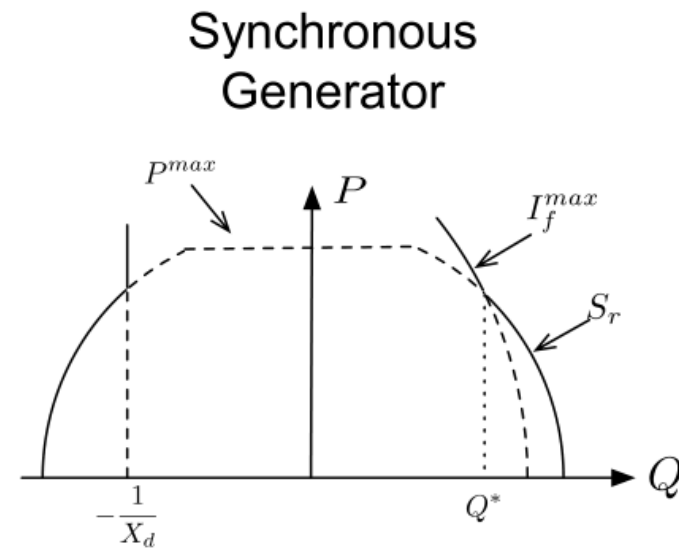
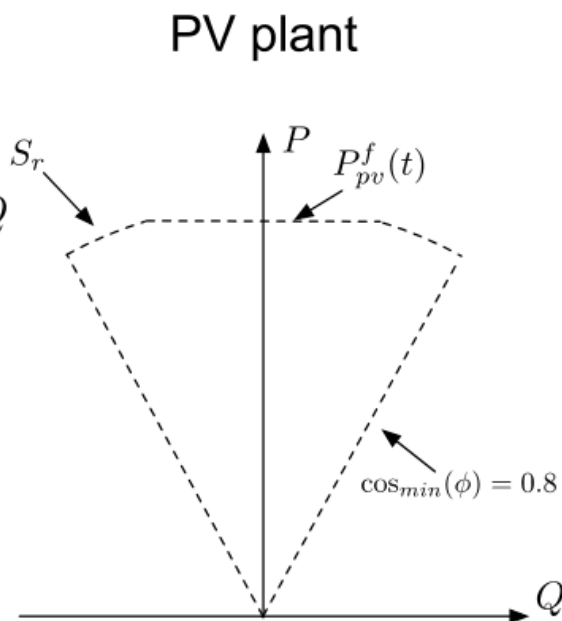
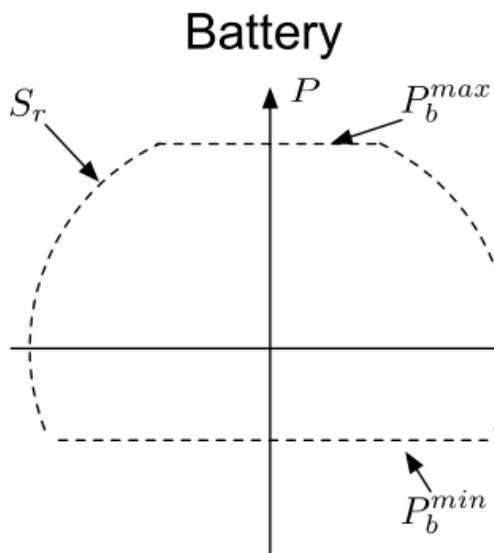

COMMELEC's Architecture – The Virtual Cost

Virtual cost: proxy for the resource internal constraints

I can do P, Q in the next t
It cost you (virtually) $C(P, Q)$

Example:

If (State-of-Charge) is 0.7
I am willing to inject power

If (State-of-Charge) is 0.3,
I am interested in absorbing power

Battery agent



Grid agent

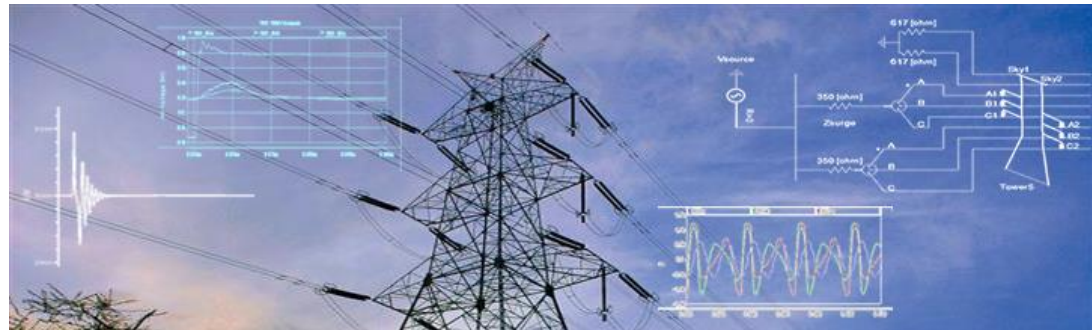

COMMELEC's Architecture – The Belief Function

- Say grid agent requests setpoint (P_{set}, Q_{set}) from a resource
- Actual setpoint **will, in general, differ**
- The **belief function** is exported by a resource agent with the semantic: resource implements $(P, Q) \in B F(P_{set}, Q_{set})$
- It gives bounds on the actual (P, Q) that will be observed when the follower is instructed to implement a given setpoint.
- Essential for safe operation.

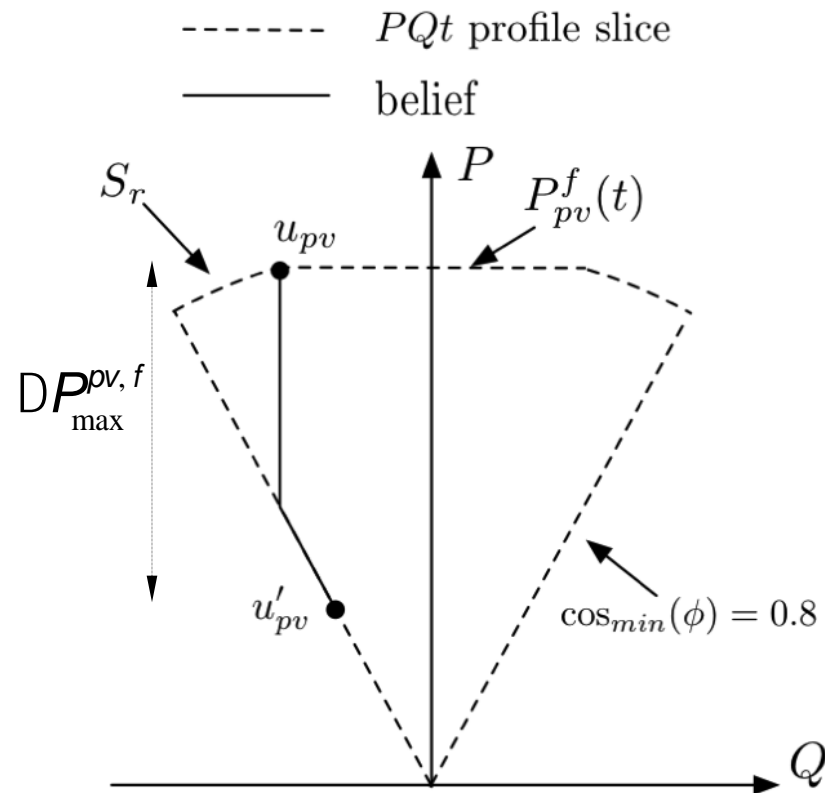

COMMELEC's Architecture – The Grid Agent's Job

Leader agent (grid agent) computes setpoints for followers based on

- the state of the grid
- advertisements received from the resources

The Grid Agent attempts to minimize

Cost of power flow at point
of common connection

$$J(\mathbf{x}) = \underbrace{\sum_i \hat{a}_i w_i C_i(x_i)}_{\text{Virtual cost of the resources}} + \underbrace{W(\mathbf{z})}_{\text{Penalty function of grid electrical state } z} + \underbrace{J_0(\mathbf{x}_0)}_{\text{Cost of power flow at point of common connection}}$$

Virtual cost of the
resources

Penalty function of grid electrical state z
(e.g., voltages close to 1 p.u.,
line currents below the ampacity)

The Grid Agent **does not see the details of resources**

a grid is a collection of devices that export PQ_t profiles, virtual costs and belief functions and has some penalty function problem solved by grid agent **is always the same**

COMMELEC's Architecture – Experimental results

Injected Power (Frequency Support)

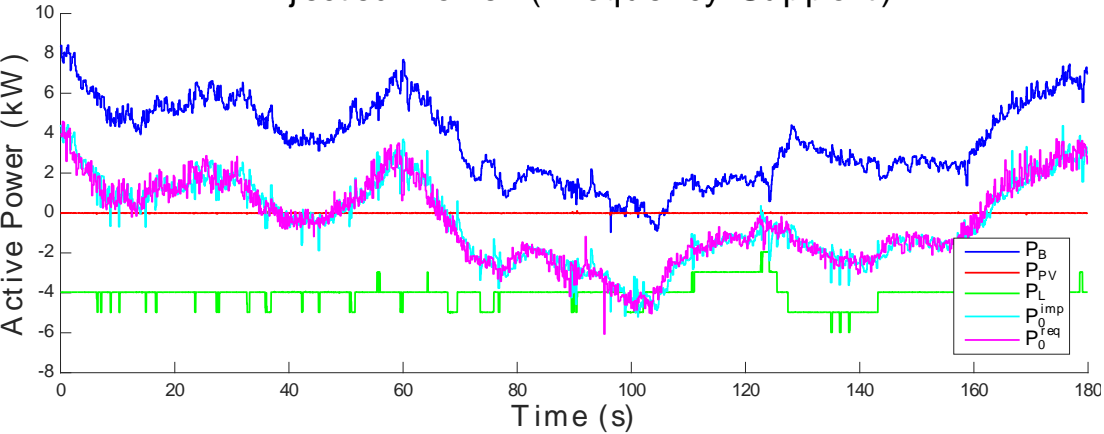

Injected Power (Reference Tracking)

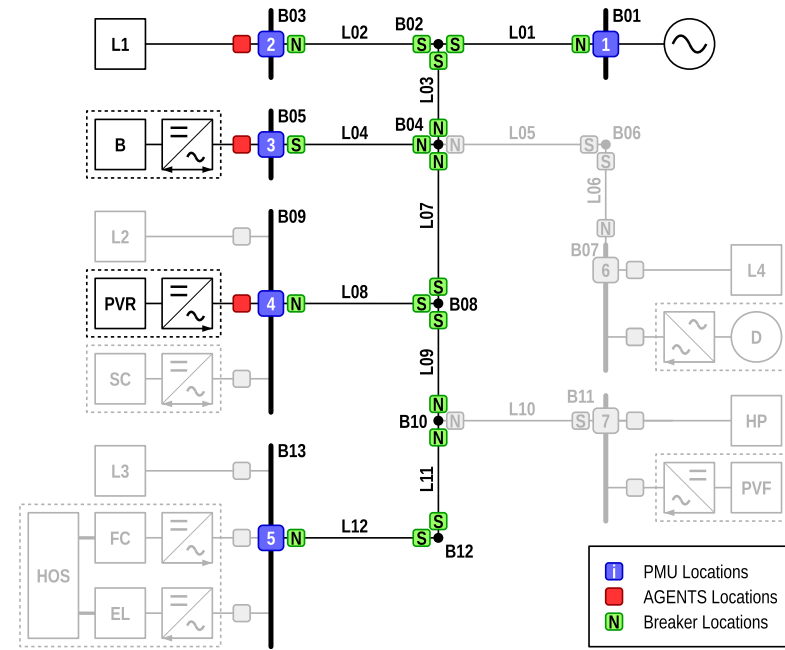
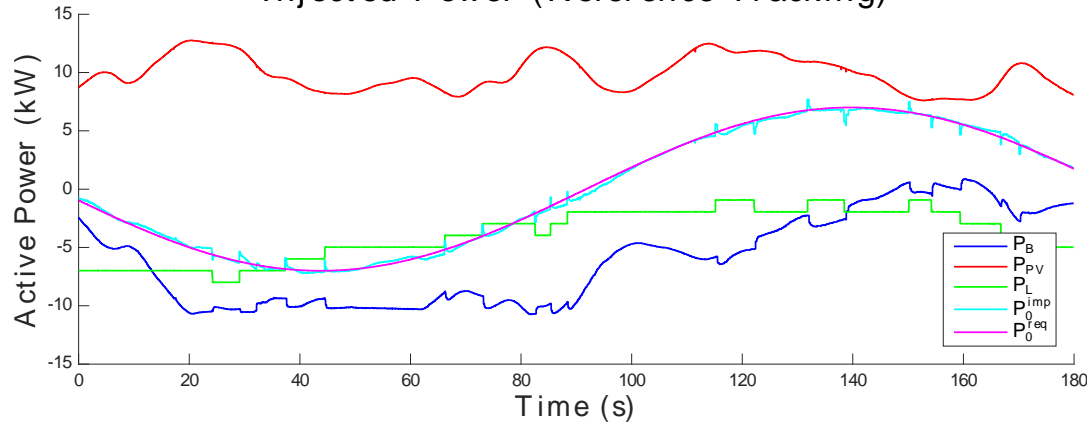

Methodological/technological challenges in smart grids

	Problem	Required methods	Required technologies
time ↓ mins-hours ↓ months	<ul style="list-style-type: none"> Renewables short-term volatility 	<ul style="list-style-type: none"> Real-time knowledge of the system state 	<ul style="list-style-type: none"> Distributed sensing (e.g. PMU) Real-time state estimators
	<ul style="list-style-type: none"> Grid congestions Voltage control 	<ul style="list-style-type: none"> Exact optimal power flow Explicit control methods Stability assessment of complex systems (low inertia) 	<ul style="list-style-type: none"> Distributed storage
	<ul style="list-style-type: none"> Heterogeneous resources aggregation Ancillary services (system stability) 	<ul style="list-style-type: none"> Real-time estimation of system flexibility Robust optimization Short-term forecast 	<ul style="list-style-type: none"> Agent-based software frameworks Demand response New technologies in pumped hydro

Robust optimization applied to local systems: why ?

- Achieving **dispatched-by-design operation** of traditionally stochastic prosumption allows **reducing grid reserve requirements**.
- The **dispatch plan** is built to satisfy a **local objective**, such as **peak shaving, load levelling** or **minimization of the cost of imported electricity**.

The topology of a dispatchable feeder (EPFL campus)

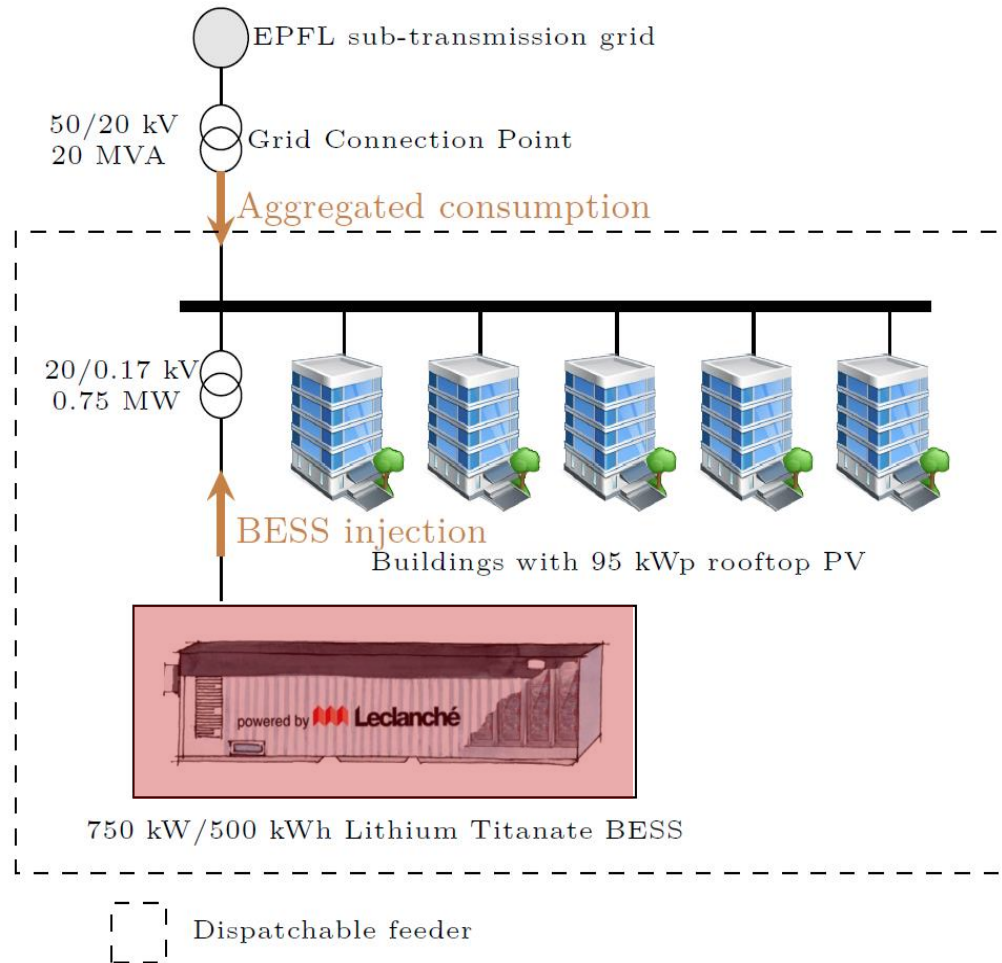

Sources of flexibility:

- physical energy storage systems

The operation of a group of stochastic prosumers (**generation + demand**) is dispatched according to a profile established the day before operation (called **dispatch plan**) by controlling the real power injection of the battery.

The DF problem formulation – A two stage process

Time (hours before the beginning of the day of operation)

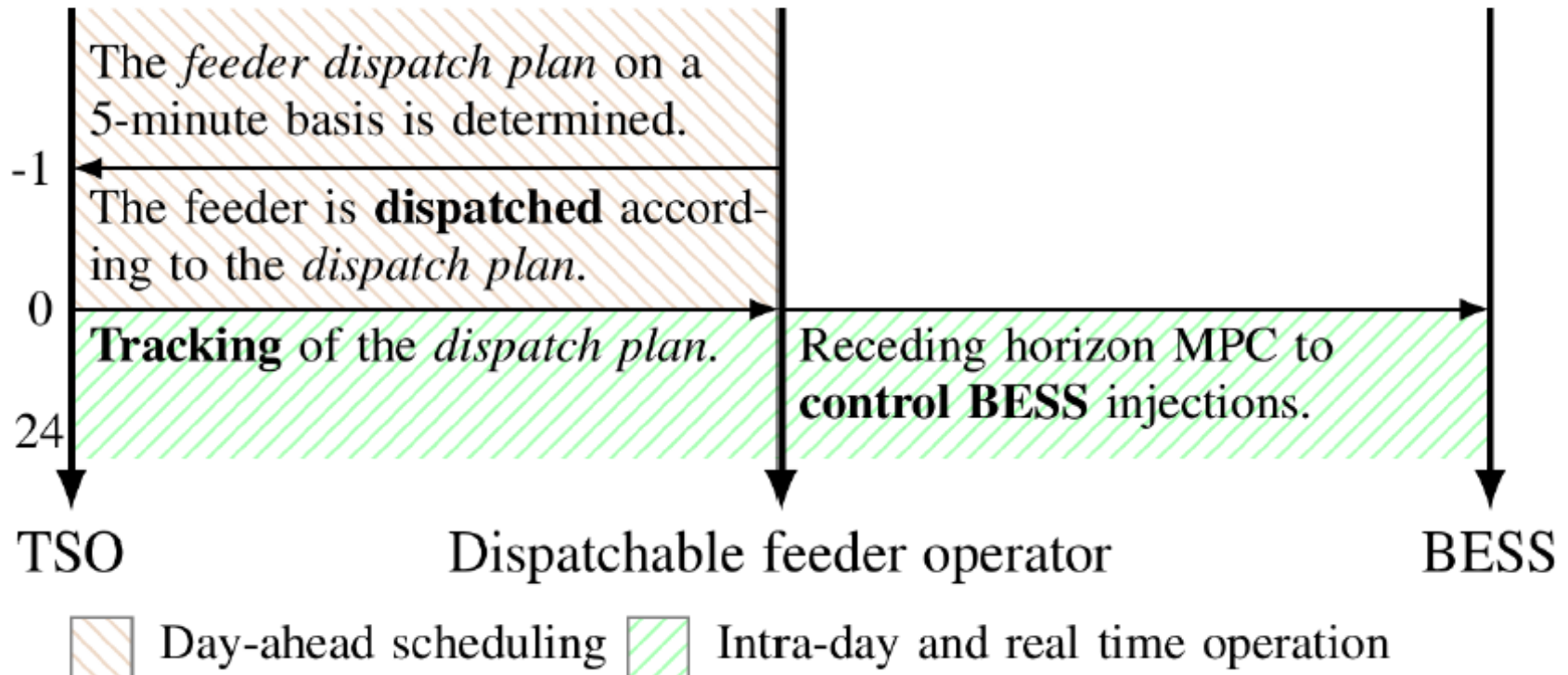

The DF experimental performances

24h dispatch of heterogeneous EPFL campus aggregated resources

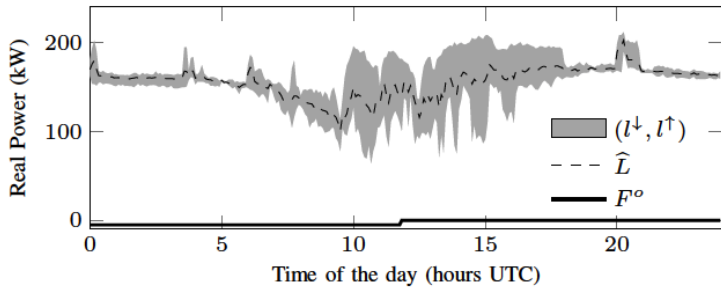

(a) Day-ahead: prosumption uncertainty sets and expected value, and offset plan.

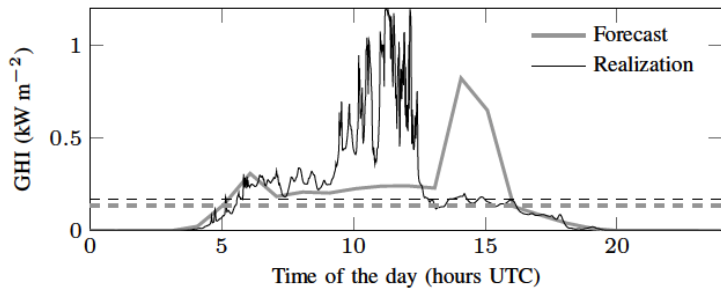

(b) GHI forecast vs realization and respective average components.

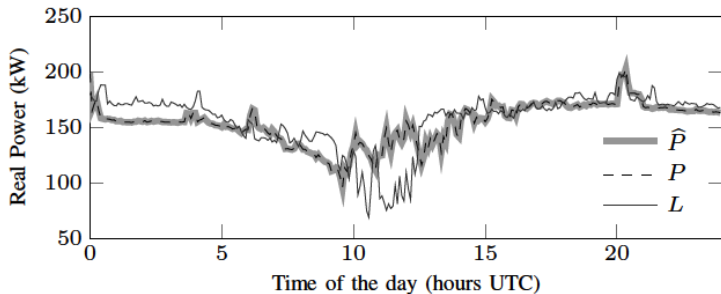

(c) Real-time: dispatch plan vs realization of GCP power transit and prosumption.

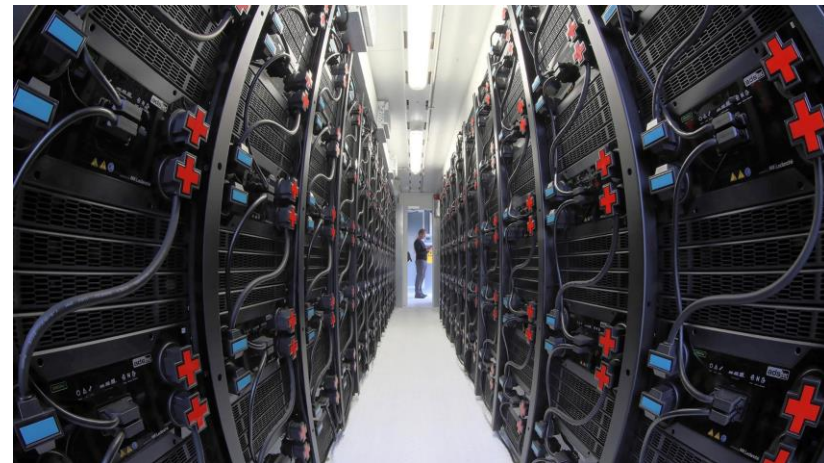
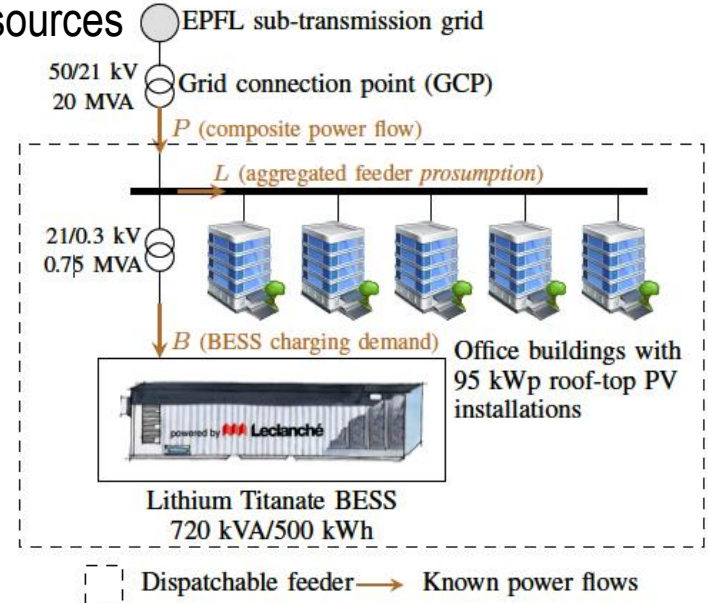

Conclusions

The **massive integration of volatile resources** is and will drive **major changes** in modern power systems and future smart grids.

Current Swiss research programs have developed new technologies and methodologies to re-engineer the sensing and control of power grids.

- **Real-time situation awareness of power systems enabling new control schemes.**
- **Seamless aggregation and control of heterogeneous energy resources via abstract control methods.**